

Template S1

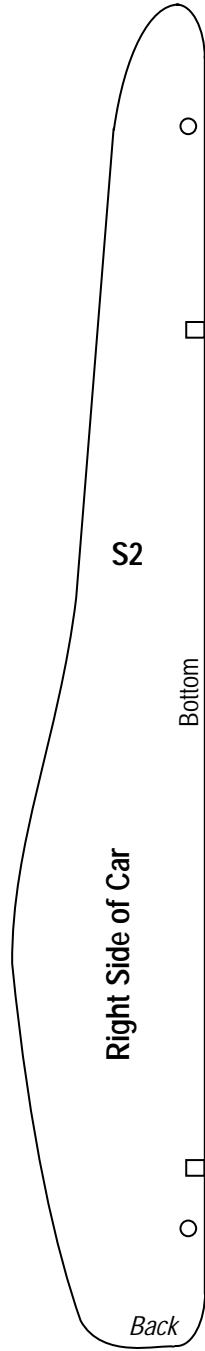

Template S2

Verify that this measurement is exactly - 7"  
If not, see "Important Printing Information" at the front of the booklet

**THE SPORTS CAR**

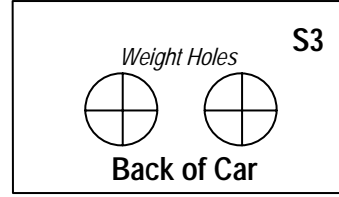

Template S3

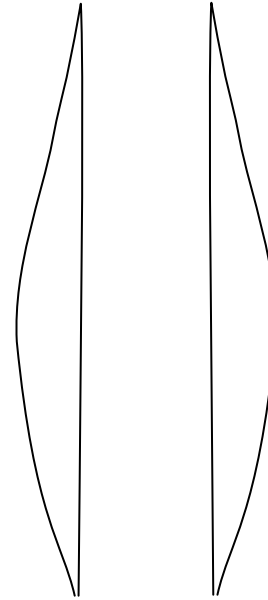

Template S4  
Left/Right Windows

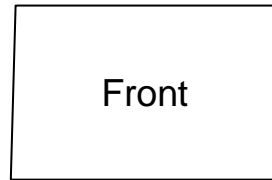

Template S5  
Front/Back Windows

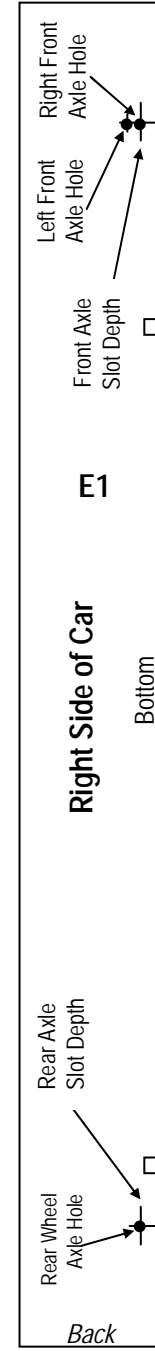

Template E1

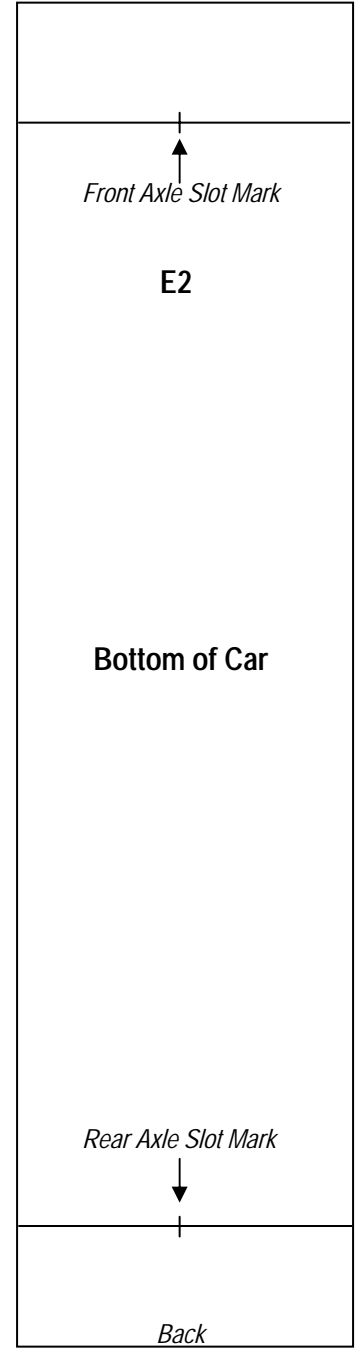

Template E2

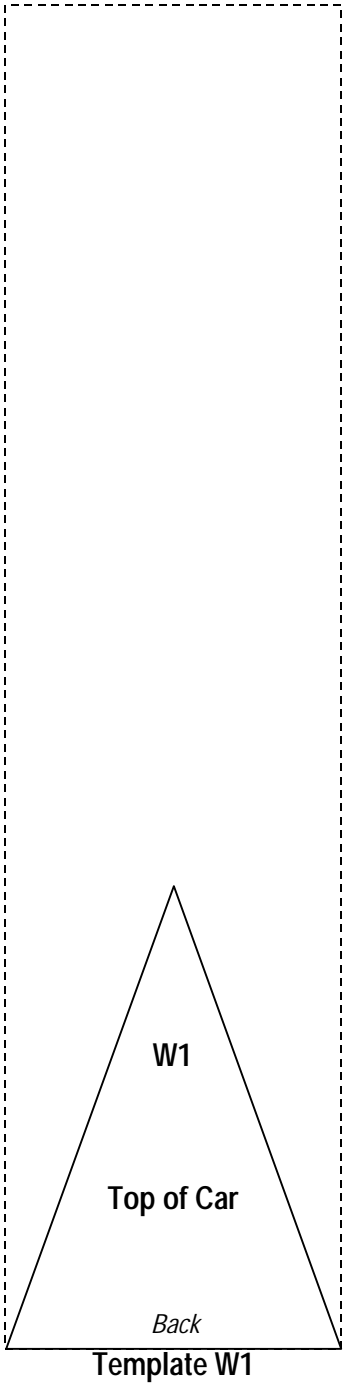

Template W1

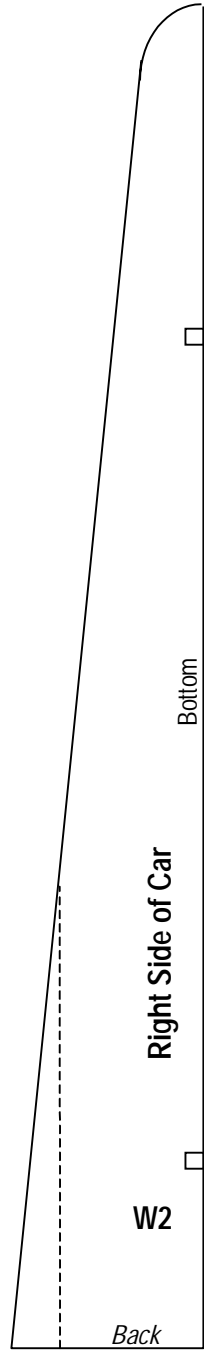

Template W2

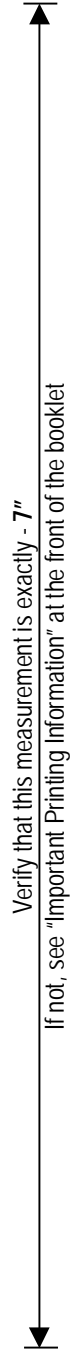

**THE WEDGE TURBO**



Star Template for Patriotic Design

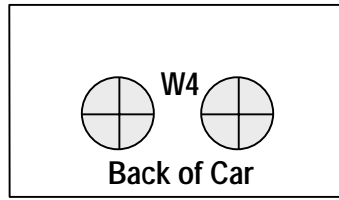

Template W4

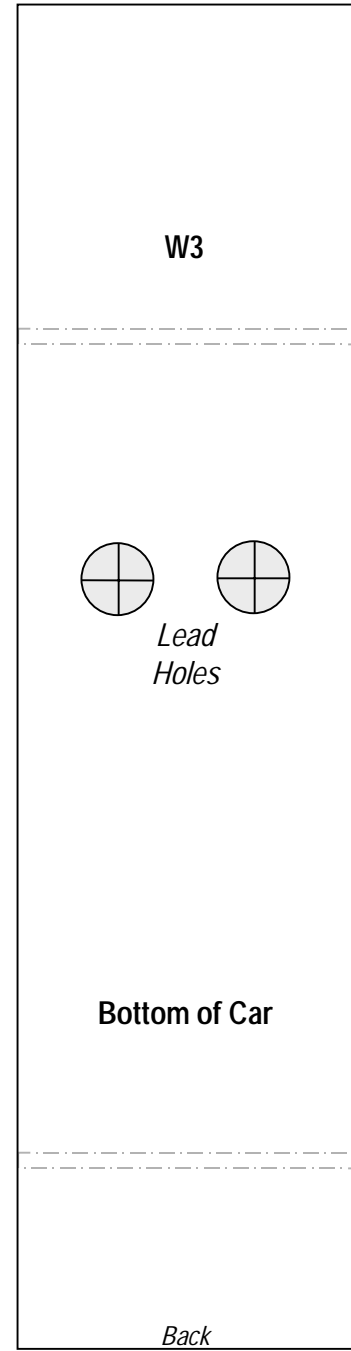

Template W3

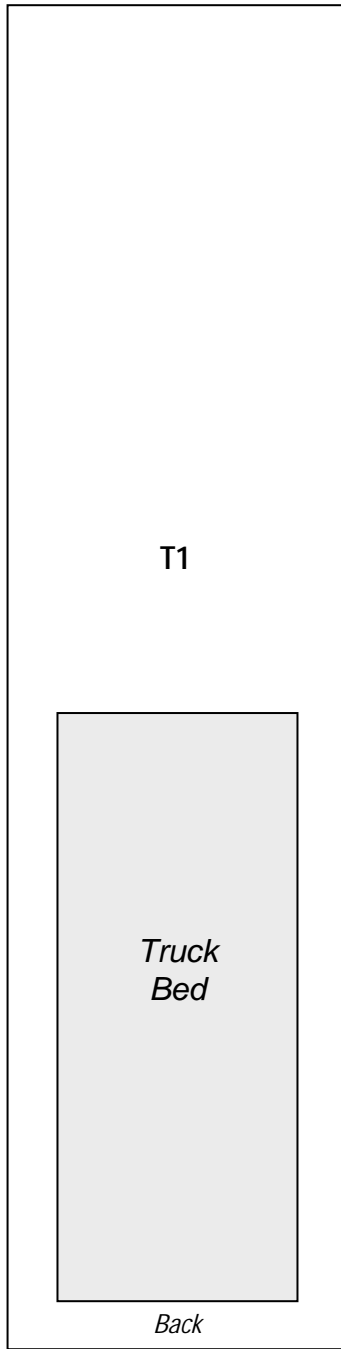

Template T1

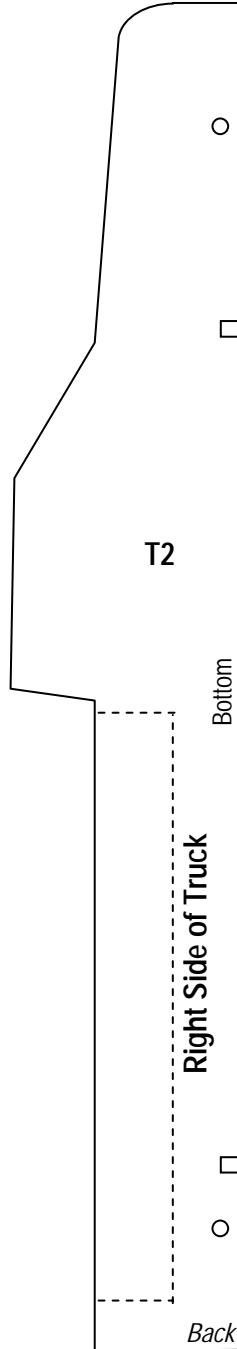

Template T2

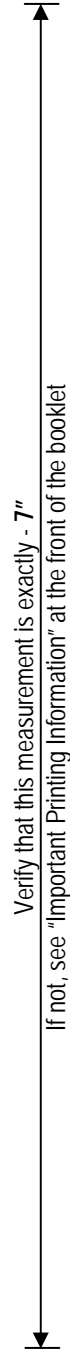

**THE TRUCK**



Template T5  
Window Outlines

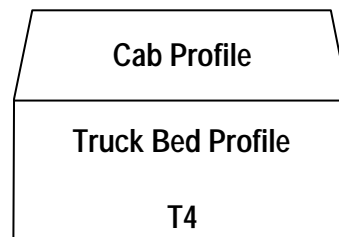

Template T4

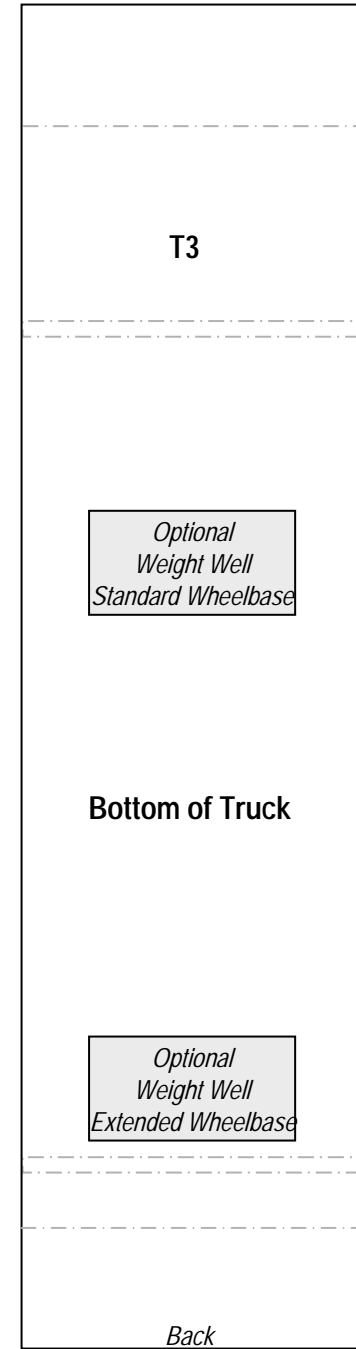

Template T3

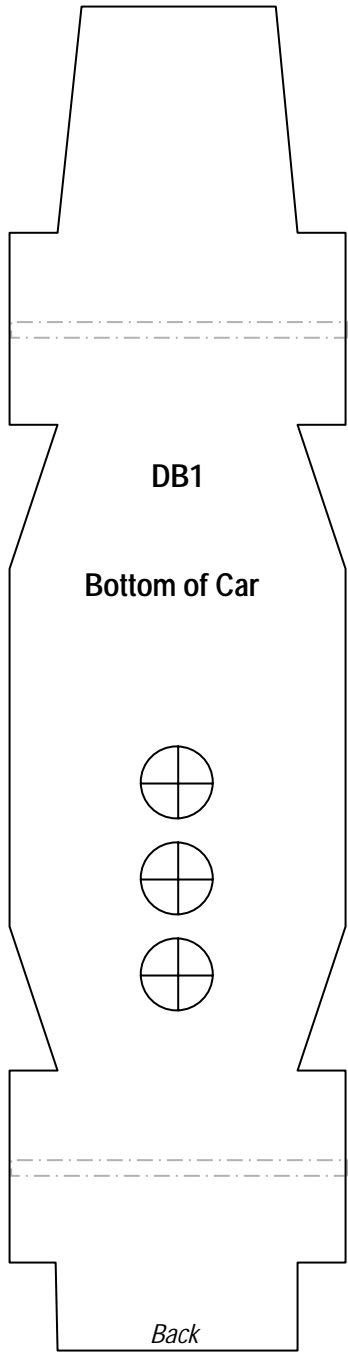

**Template DB1**  
Bottom of Car

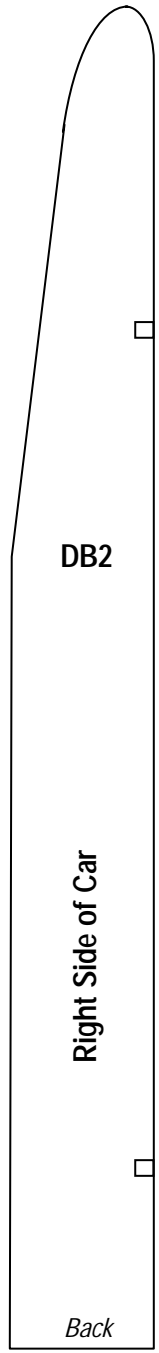

**Template DB2**  
Right Side of Car

Verify that this measurement is exactly - 7"  
If not, see "Important Printing Information" at the front of the booklet

**THE DUNE BUGGY**

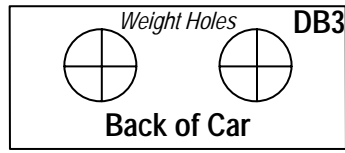

**Template DB3**  
Right Side of Car

A Use DB4 and DB5



C Use DB4

D Use DB5

**Template DB4**  
Frame Members

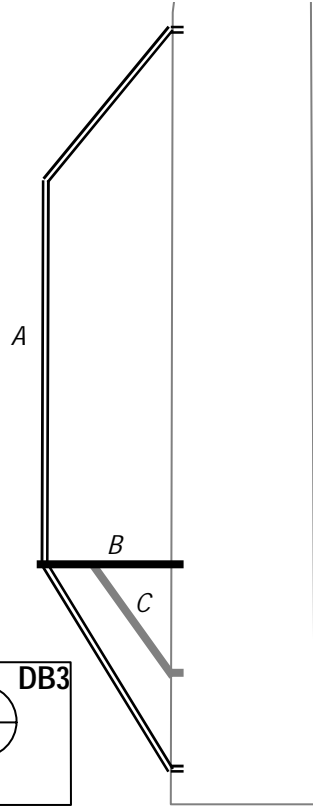

**Template DB4**  
Side View of Frame

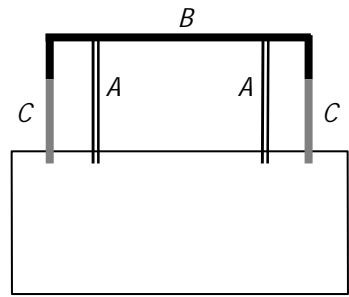

**Template DB7**  
Rear View of Frame

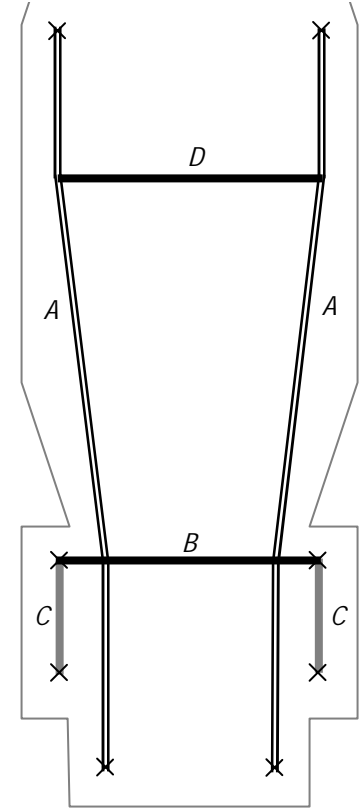

**Template DB5**  
Top View of Frame